

Article number: 2310306935

Description: E+G Levelling element
LV.A-125-ACV-M24x186

Measures

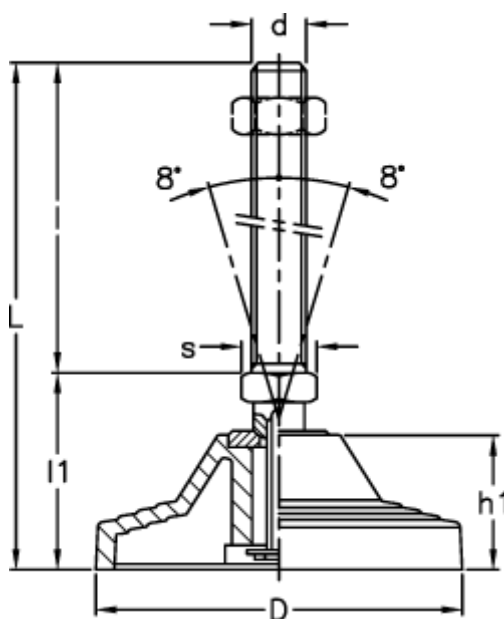

d	= M24
D	= 125
h	= 45
l	= 186
L	= 250
l1	= 64
Max load (N)	= 40000
s	= 24